

JuicePedestal User Manual

ENGLISH



enel  way

Table of contents

Welcome	3
Site Design Guide	3
Installation Area	4
Installation of 32A, 40A, 48A JuicePedestal	4
Installation of 80A JuicePedestal	7
Replace a JuiceBox	12
Replace Retractor	20
Credit Card Reader (CCR)	27
Enterprise Setup	30
Introduction	30
Quick Guide for Administrators	30

Welcome

This manual explains how to install the JuicePedestal.



Site Design Guide

For more details, refer to [Site Design Guide](#).

Installation Area

Refer to the [Enel X Way Site Design Guide](#).

Installation of 32A, 40A, 48A JuicePedestal

Each JuiceBox must be on its own circuit. Refer to the [Wiring Design section of the Enel X Way Site Design Guide](#) for additional information.



NOTE:

- > The JuicePedestal must be installed in accordance with the National Electrical Code (NFPA 70) and all applicable local jurisdiction requirements.
- > Junction Boxes must be UL Listed or UL Certified for outdoor-use due to local regulations, if necessary.
- > Conduit fittings must be liquid-tight and UL Listed or UL Certified for outdoor-use.

1. Turn off the mains power to the hardwire connections.
2. Use a multimeter to ensure that there is no power at the hardwire connections.



WARNING: Do not continue with the installation until the multimeter shows that there is no power at the hardwire connections to mains.

3. Route the mains power hardwire connection into the pedestal from the bottom, then position the pedestal onto the ground stud anchors.
4. Secure the pedestal to the ground stud anchors (refer to [Installation Area](#) for more information).

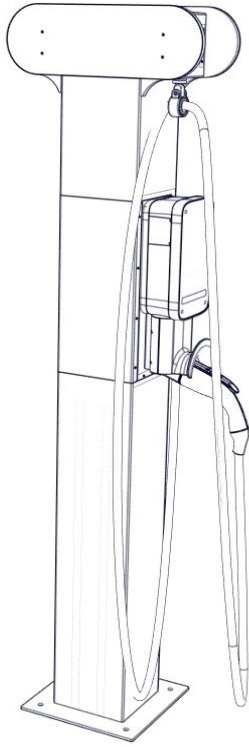

5. Release the 10 fasteners that secure the back plate to the pedestal. Remove the back plate.

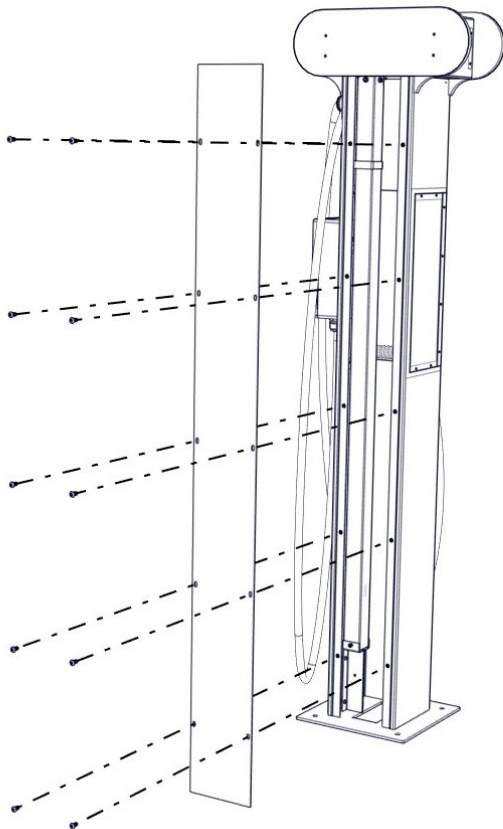

6. For each JuiceBox, install a waterproof junction box to house the connection.



NOTE: The JuiceBox flex conduit has a diameter of 1 in.

7. Connect the mains power wires to the charging station wires.

BLACK	RED	GREEN
L1	L2	Ground

8. Reinstall the back plate (refer to step 5).

9. Reconnect power to the hardwire connections. The charging stations turn on automatically.

Installation of 80A JuicePedestal



NOTE:

- > The JuicePedestal must be installed in accordance with the National Electrical Code (NFPA 70) and all applicable local jurisdiction requirements.
- > Connectors must be UL Listed or UL Certified for outdoor-use due to local regulations, if necessary.
- > Conduit fittings must be liquid-tight and UL Listed or UL Certified for outdoor-use.
- > Charging station wires are already connected to the connector.

1. Turn off the mains power to the hardwire connections.
2. Use a multimeter to ensure that there is no power at the hardwire connections.



WARNING: Do not continue with the installation until the multimeter shows that there is no power at the hardwire connections to mains.

3. Route the mains power hardwire connection into the pedestal from the bottom, then position the pedestal onto the ground stud anchors.
4. Secure the pedestal to the ground stud anchors (refer to [Installation Area](#) for more information).

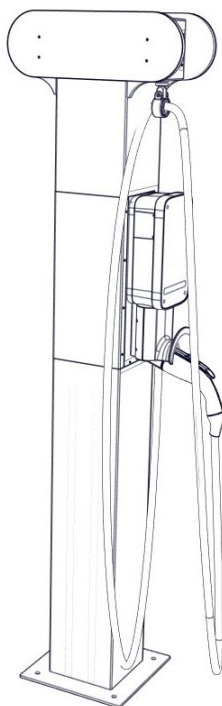

5. Release the 10 fasteners that secure the back plate to the pedestal. Remove the back plate.

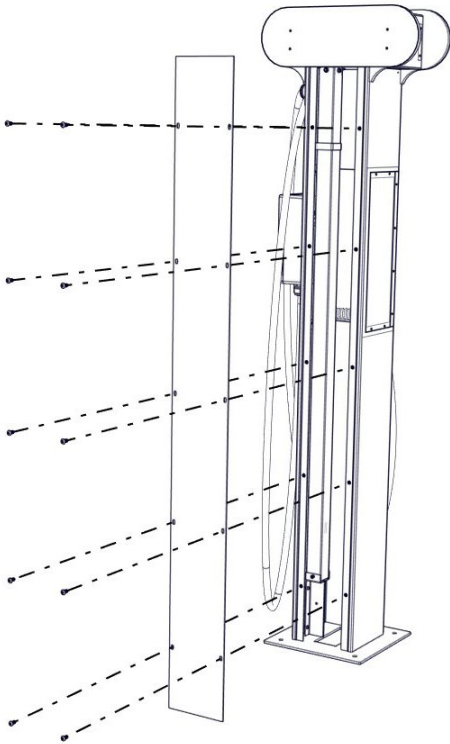

6. Remove the mains power wire (L1, L2, Ground) insulation.



NOTE: Strip the insulation of the wire only as much as is necessary.

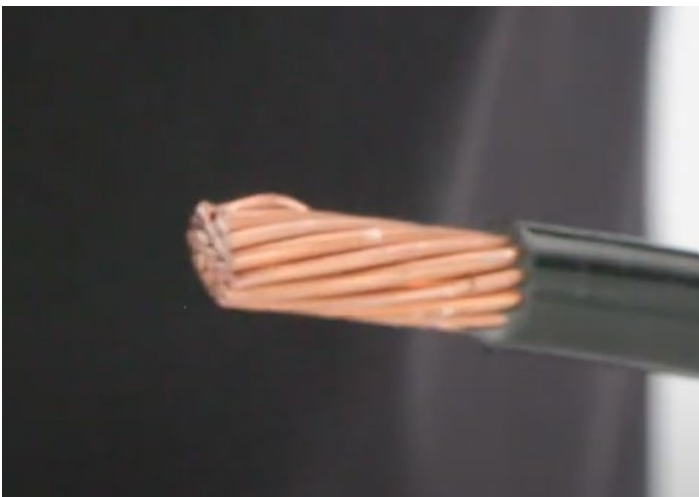

7. Remove the sleeve from the connector port and cut at the appropriate mark from the wire being used.



NOTE: Make sure to cut the sleeve straight across the ends to ensure a tight seal between the wire and the sleeve.



NOTE: If the wire diameter size (including insulation) is of the maximum size of the sleeve, then discard the sleeve. If the sleeve is discarded, refer to step 9.



8. Reinsert sleeve again into the connector port.

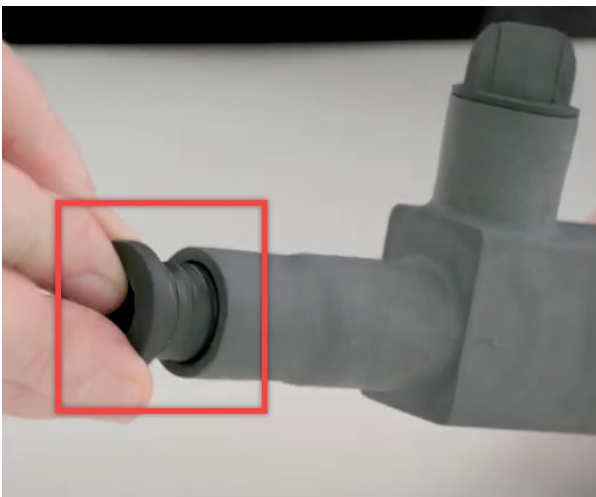

9. Remove the set screw access plug.

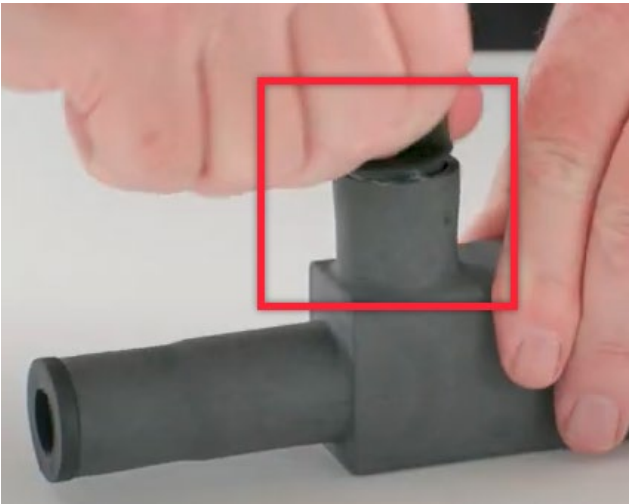

10. Using the 3/16" hex key, loosen the set screw.

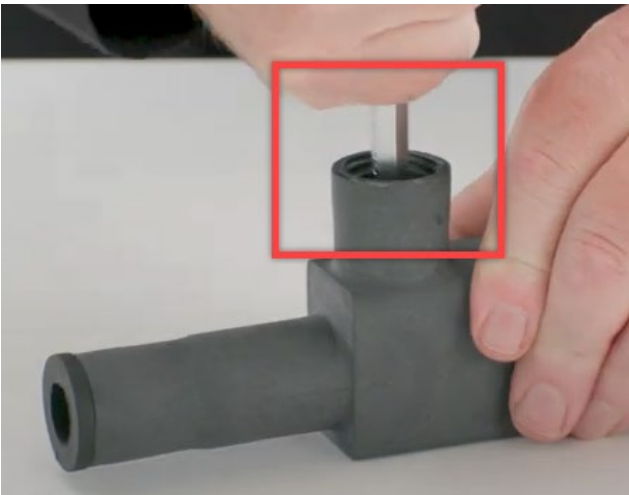

11. For easy assembly of wire to the connector, apply the silicone grease to the wire insulation.

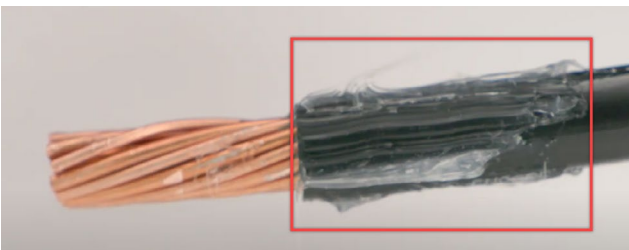

12. Insert the mains power wire (L1, L2, Ground) into the connector port and make sure that the tip of wire touches at the back of the connector.

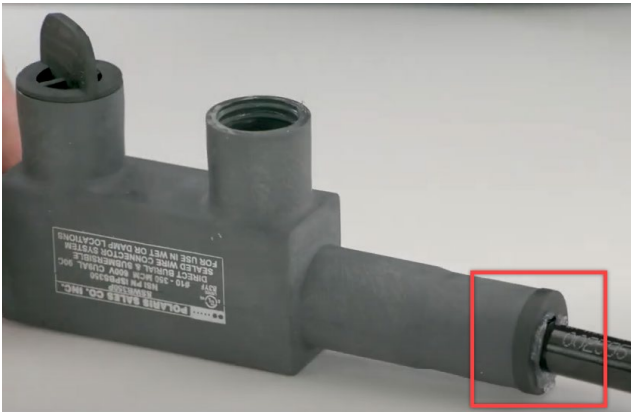

BLACK	RED	GREEN
L1	L2	Ground

13. Tighten the set screws to the recommended torque value.

WIRING RANGE (MCM/AWG)	MAX TORQUE (IN LBS)
#4 - #6	120
#1 - #3	120
2/0 - 1/0 AWG	120

14. Reinsert the set screw access plugs (refer to step 9).

15. Reinstall the back plate (refer to step 5).

16. Reconnect power to the hardwire connections. The charging station turns on automatically.

Replace a JuiceBox

This section describes how to replace a JuiceBox which is installed on a JuicePedestal.

i **NOTE:** Do not discard any parts or fasteners unless explicitly instructed to do so.

1. Turn off all the circuit breakers that supply power to the pedestal.

i **NOTE:** Use a multimeter to ensure that wires supplying power to the pedestal indicates a zero voltage, as there may be more than one circuit in the junction box.

2. Release the 10 fasteners that secure the back plate to the pedestal. Remove the back plate.

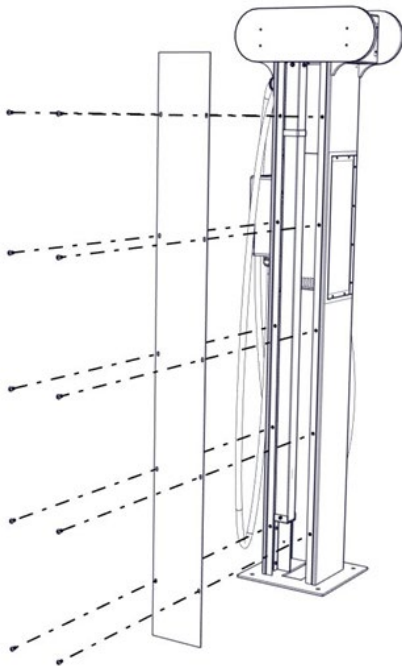

3. To disconnect the electrical connection to the JuiceBox, do the following steps:
 - a. Remove the cable gland fitting that secure the conduit from JuiceBox to the junction box.



- b. Open the junction box within the pedestal and disconnect the connecting means within the junction box.



- c. Use a multimeter to ensure that there is no power at the hardwire connections.



WARNING: Do not continue with this procedure until the multimeter shows that there is no power at the hardwire connections to mains.



d. Disconnect the JuiceBox wiring from the incoming power wiring in the junction box.



4. If the JuiceBox is connected to the (CCR), disconnect the Ethernet cable(s) from the back cover of the payment terminal.

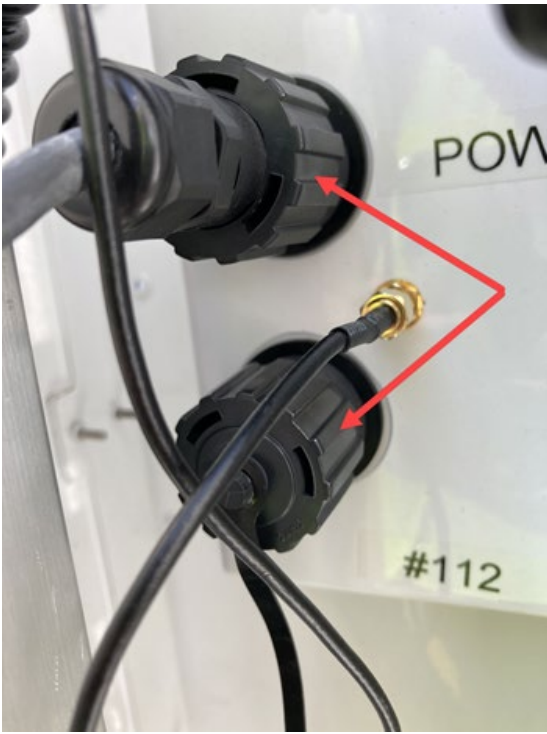

5. If the JuiceBox is connected to the JuiceRouter, disconnect the Ethernet cable from the port on the base of the JuiceRouter.



6. Release the screw that secures the cable holder ring, and then release the cable holder ring from the retractor.



7. Use a flat head screw driver to remove the locking rings from the cable holder ring. Remove the cable holder ring from the cable.



8. Release the 2 phillips head screws that secure the JuiceBox to the side panel of the pedestal.



9. Remove the Ethernet cable and conduit gland of old JuiceBox from the holes on the side panel. Remove the old JuiceBox.



NOTE: Carefully remove the ethernet cable from the hole on the side panel to avoid any damage to the connector.

10. Route the Ethernet cable and the conduit gland of the new JuiceBox into the holes on the side panel. Position the JuiceBox onto a pedestal (refer to step 9).
11. Reinstall the 2 phillips head screws to secure the JuiceBox to the side panel of the pedestal (refer to step 8).
12. Add the rubber strip around the cable, position the cable holder ring on the cable and install the locking rings on the cable holder ring.



13. Install the cable holder ring onto the stopper.



14. Connect the Ethernet cable to the port on the base of the JuiceRouter (refer to step 5).
15. Connect the Ethernet cable(s) to the back cover of the payment terminal (refer to step 4).
16. To connect the electrical connection to the JuiceBox, do the following steps:
 - a. Insert the new JuiceBox wires and conduit into the junction box (refer to step 3d).
 - b. Connect the JuiceBox wires to the incoming power wiring using the original connecting means and close the junction box (refer to step 3b).
 - c. Tighten the cable gland fitting that secure the conduit from JuiceBox to the junction box (refer to step 3a).
17. Reinstall the back plate (refer to step 2).
18. Turn on all the circuit breakers that supply power to the pedestal. The JuiceBox turns on automatically and the LED indicator flashing to blue color.

Replace Retractor

This section describes how to replace a retractor.



NOTE: Do not discard any parts or fasteners unless explicitly instructed to do so.

1. Release the 10 fasteners that secure the back plate to the pedestal. Remove the back plate.

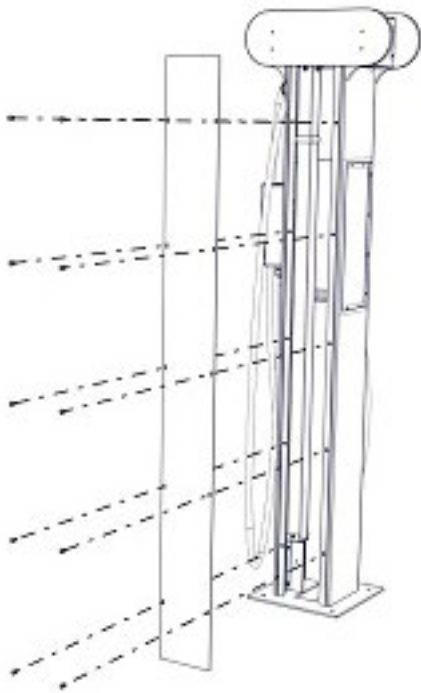

2. Release the 8 fasteners that secure the frontplate to the pedestal. Remove the frontplate.

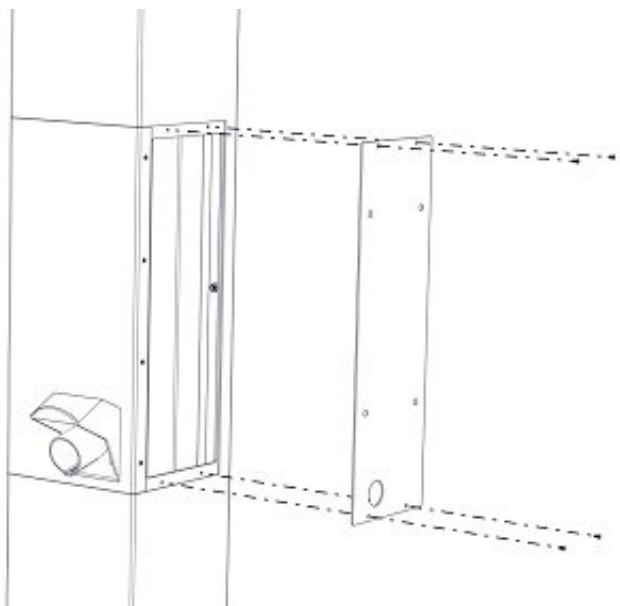

3. Use a T9 Torx Security bit to release the fasteners that secure the top plate.



4. Release the screw that secures the cable holder ring, then release the cable holder ring from the retractor.



5. Use a flat head screw driver to remove the locking rings from the cable holder ring. Remove the cable holder ring from the cable.



6. While restraining the nut on the opposite side, use a 5/64 in hex key to release the fastener that secures the upper pole bracket to the pedestal. Remove the upper pole bracket from the pedestal.

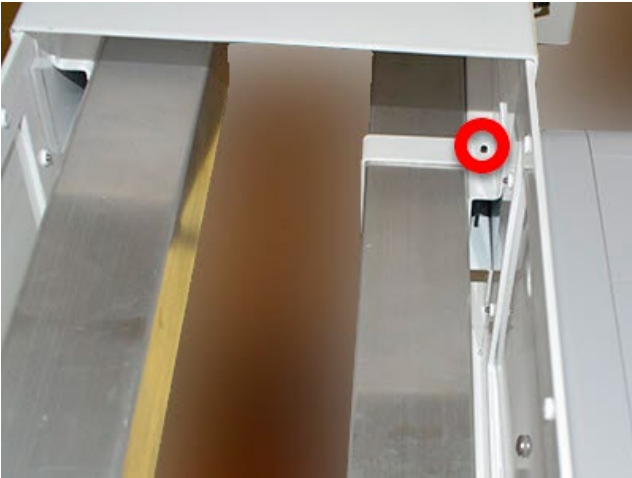

7. Release the fasteners (x4) that secure the lower pole bracket from the pedestal.



NOTE: Do not remove the lower pole bracket at this time.



NOTE: 2 of the fasteners are not easily visible.



8. Remove the retractor assembly by lifting it upwards, then out of the pedestal.



NOTE: The bracket from step 7 is removed as part of the retractor assembly.



9. While restraining the nut on the opposite side, use a 3/16 in hex key to release the fastener that secures the lower pole bracket to the retractor assembly.



10. Transfer the lower pole bracket to the new retractor assembly.
11. Position the retractor assembly within the pedestal (refer to step 8).
12. Reinstall the fasteners that secure the lower pole bracket to the pedestal (refer to step 7).



TIP: Hand tighten the front (visible) fasteners before installing the rear (hidden) fasteners. When all fasteners are hand-tight, fully tighten the hidden fasteners first, then fully tighten the visible fasteners.

13. Reinstall the fastener that secures the upper pole bracket to the pedestal (refer to step 6).



TIP: Push the retractor pole towards the outside of the pedestal to properly install the fastener.

14. Untie the knot and remove the washer from the retractor cord.



15. Install the stopper:



NOTE: Read this entire step before continuing.

- a. Pull down on the retractor cord until you feel the tension from the counterweight, then pull the retractor cord out 1 additional inch. Hold the cord in this position.
- b. While continuing to hold the cord in place from the previous step, install the stopper onto the retractor cord. Slide the stopper all the way to the top of the cord.



- c. Use a marker to mark the position of the bottom of the stopper on the cord. Ensure that the stopper remains above this mark during the next steps.
- d. Pull out the cord and tie a knot at the position that was marked previously.
- e. Install the clamshell over the knot.



- f. Slide the stopper over the clamshell.



- g. Cut any excess cord away from the base of the stopper. Use a lighter to melt the end of the cord to prevent fraying.
 - h. Let go of the cord so that the stopper rests inside its housing on the pedestal.
16. Pick up the charging cable from the charging cable holder. Fully lay out the charging cable onto the ground.
17. Create one loop in the charging cable, so that the base of the loop hangs one inch off the ground and the top of the loop is at the same height as the stopper. Mark the position on the cable that is at the same height as the stopper.



18. Install the cable holder ring onto the cable at the position that was marked in the previous step (refer to step 5).
19. Install the cable holder ring onto the stopper (refer to step 4).
20. Reinstall the top plate (refer to step 3).
21. Reinstall the front plate (refer to step 2).
22. Reinstall the back plate (refer to step 1).

Credit Card Reader (CCR)

You can use Apple Pay, Google Pay, tap with the credit card, insert or swipe your credit card to pay for the charging of your EV through CCR. You can upgrade the JuicePedestal to include a CCR. This manual explains how to install an Credit Card Reader (CCR) to the JuicePedestal.

1. Remove the old front panel from the JuicePedestal.



2. Hold the CCR assembly near the JuicePedestal.

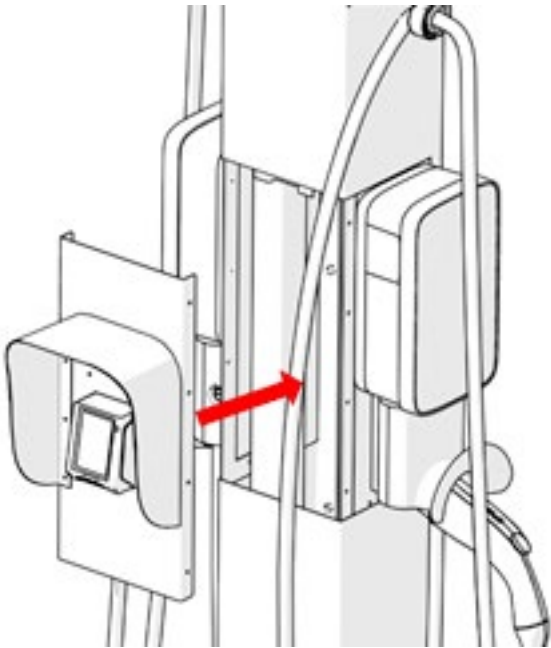

3. Connect the serial cables from both the JuiceBox to the RJ45 adapters on the back cover. Turn the cable connectors clockwise until they are latched.

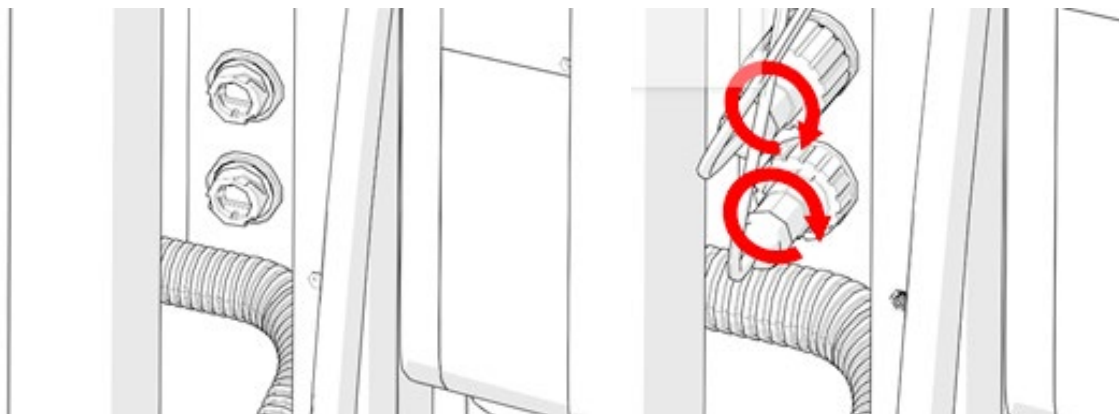

4. Connect the SMA plug from the antenna to the SMA bulkhead on the back of the CCR and make sure the connection is tight.



NOTE: Apply the torque of 5 in lbs while connecting the SMA plug to the SMA bulkhead.

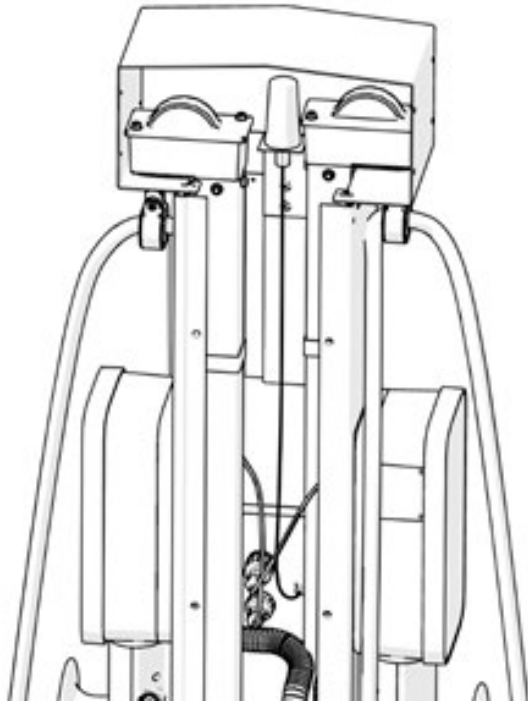
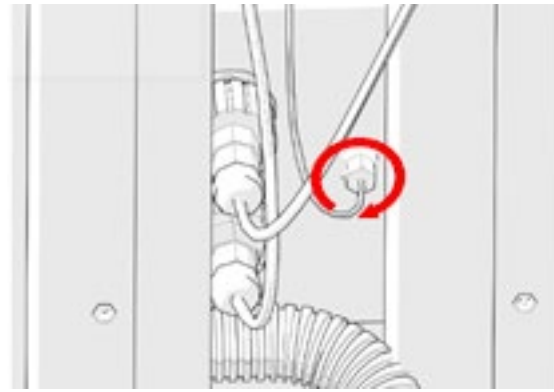
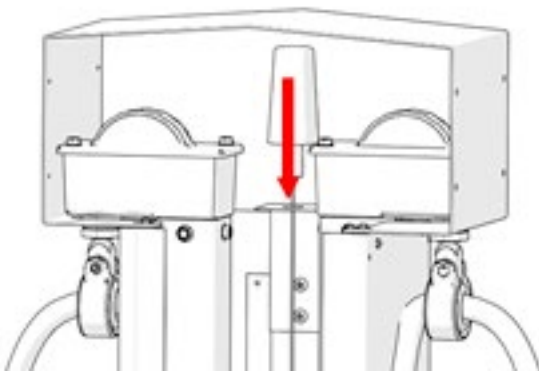

5. Place the whole CCR assembly on the JuicePedestal.

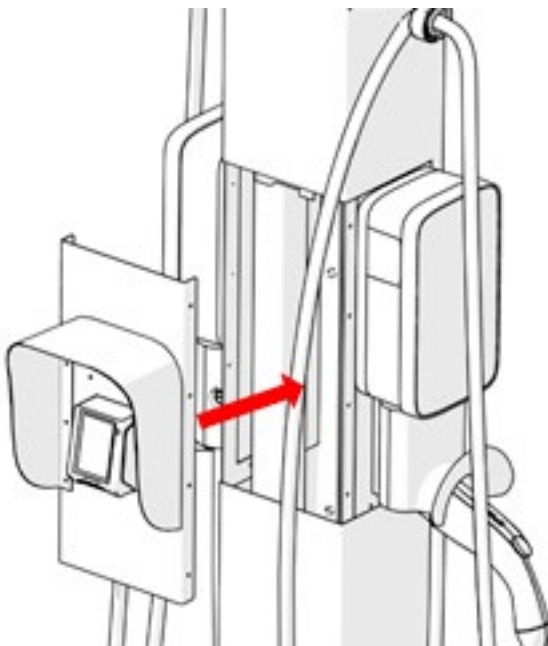

6. Install the screws (x8) from both the sides to secure the CCR assembly to the JuicePedestal.



NOTE: Apply the torque of 5.2 in lbs to tighten the screws.

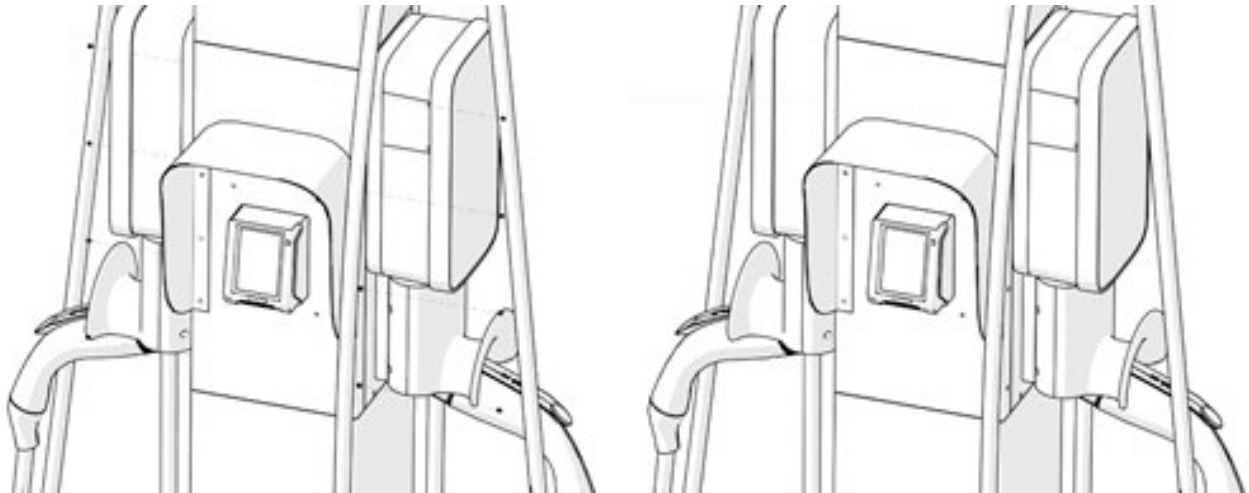

For more information, refer to [Frequently Asked Questions](#) of CCR.

Enterprise Setup

Introduction

JuiceNet Enterprise has a host of powerful features for controlling the electric vehicle charging experience, both for you and for your customers.

Quick Guide for Administrators



NOTE: This section requires an account with [Heartland Payment Systems](#). Do not begin this quick guide until your account has been established.

1. Create a rate. **Rates** are payment structures. JuiceBox OpenPay can charge customers a flat fee for charging, or can charge based on the length of charging time or amount of electricity used. Refer to [Create Rate](#) in the JuiceNet Enterprise Manual.
2. Create a **location**. A location represents one or more JuiceBox OpenPay devices in the same general area. We'll add the individual devices in the next step, but it's helpful to create the location first. Refer to [Add New Location](#) in the JuiceNet Enterprise Manual.
3. Enable public access to the location. Refer to [Enable or Disable Public Access To Location](#) in the JuiceNet Enterprise Manual.
4. Add individual JuiceBox OpenPay **devices** to your Dashboard. Refer to [Add New Device](#) in the JuiceNet Enterprise Manual.
5. Set up the payment account:
 - a. In the upper right corner of the dashboard, select the **User Profile** icon. In the popup, select the **User Profile** icon.

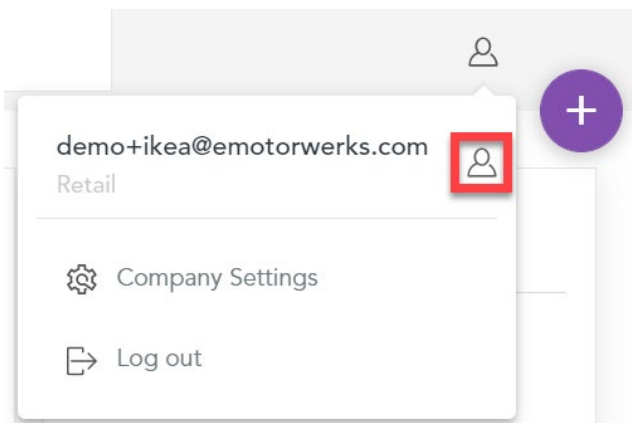

- b. Select **Payment Settings > Payment Terminal**.

My profile **Payment Settings**

Payment Terminal Automatic Payment Statement Billing

Set up your Heartland account **Heartland**

This is where you link your account with Heartland in order to receive payments. Retrieve and enter the right details in the respective areas using the guides below.

Terminal Serial Number	Site ID	License ID	Device ID	Login	Password
No available terminals	<input type="text" value="Site Id"/> <small>Site Id is required</small>	<input type="text" value="License Id"/> <small>License Id is required</small>	<input type="text" value="Device Id"/> <small>Device Id is required</small>	<input type="text" value="Login"/> <small>Login is required</small>	<input type="password" value="Password"/> <small>Password is required</small>

+ Add new field

- c. Open the welcome email from Heartland, where you can find your Heartland account information (Site ID, License ID, Device ID, Login, and Password).
- d. In the "Terminal ID" dropdown menu, select your terminal ID.
- e. Input your Heartland account information (Site ID, License ID, Device ID, Login, and Password) into JuiceNet Enterprise, then select **Save**.



NOTE: The Site ID and License ID should be the same for each terminal.



NOTE: Enter the "Software ID" received from Heartland in the welcome email into the **Login** box and change the default password received in the welcome email from Heartland to the new password of your choice before using it in the **Password** box.

For more information on using the JuiceNet Enterprise, refer to the [JuiceNet Enterprise Manual](#).